

Speers Outdoor Light Source

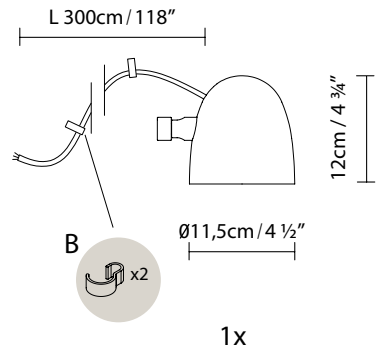

Speers Outdoor F Accessory

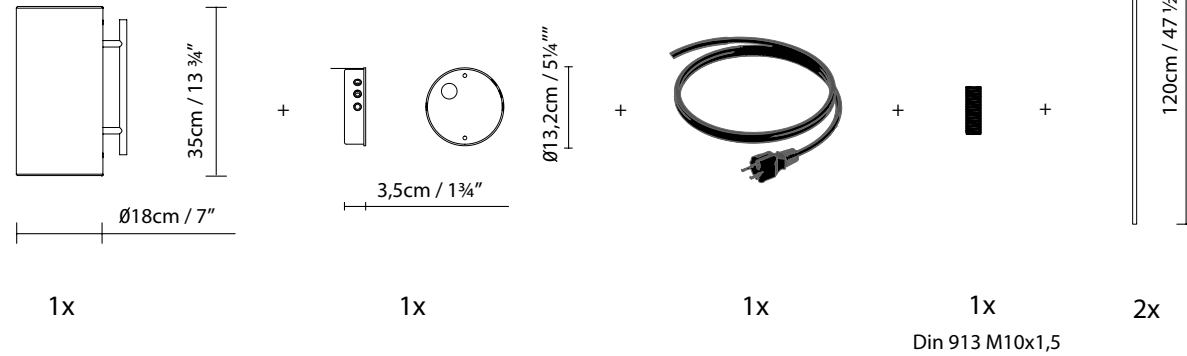

Speers Outdoor C Accessory

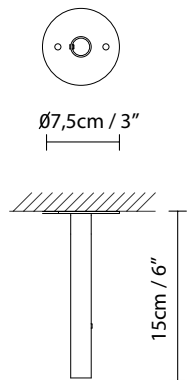

Speers Outdoor Angle Accessory (2x)

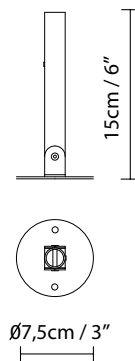

Speers Outdoor W Accessory

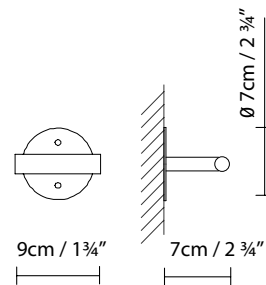

Speers Outdoor Stem Accessory 120 / 150

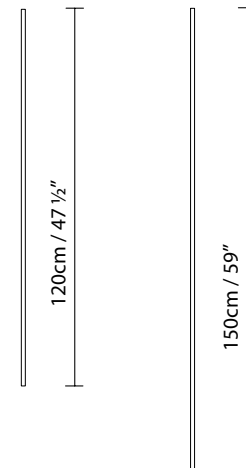

Speers Outdoor Connection Box

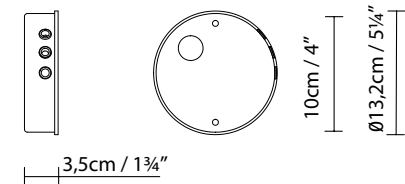

Samples

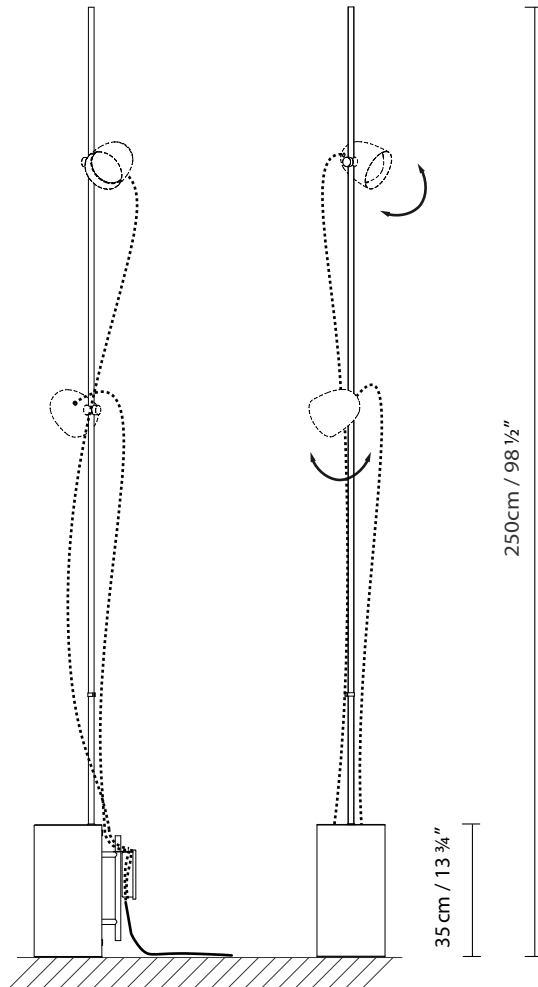

Sample 1: Speers Outdoor F Accesory  
+ 2 Light Source

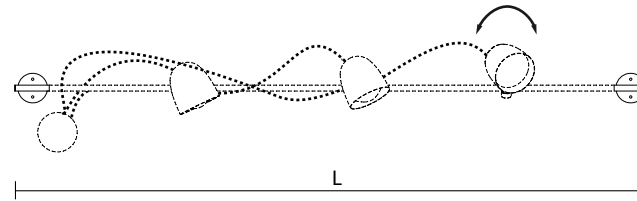

Sample 2: 2 Speers Outdoor W Accesory  
+ 3 Light Source + Connection Box + Stem (L)

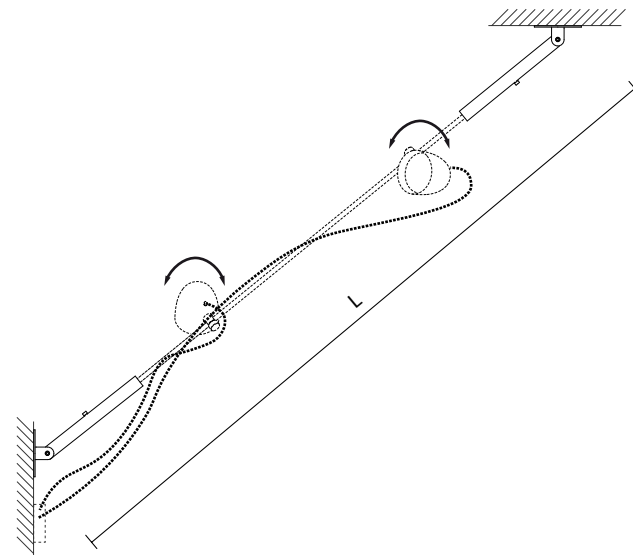

Sample 3: Speers Outdoor Angle Accesory  
+ 2 Light Source + Connection Box + Stem (L)

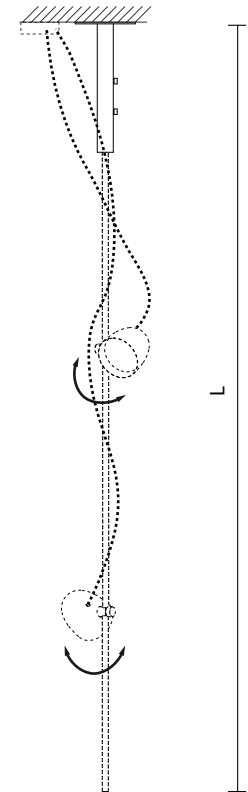

Sample 4: Speers Outdoor C Accesory  
+ 2 Light Source + Connection Box + Stem (L)

\*Max. 3 light sources per connection box.